



# AIRLINES, FITTINGS & ACCESSORIES

Catalogue



Air Hoses



Air Hose Connectors



Couplers and Adaptors

## Tire and Wheel Service Solutions

Prema Canada is one of the largest distributors of tire and wheel service supplies and is a market leader in delivering a total supply solution to the tire industry in Canada. Founded in 1954 as Loomis Root Canada Ltd, the company has evolved from a small, regional automotive and retread supply distributor into a focused network of independent tire and wheel service supply Distributors servicing the entire country from coast to coast.

[www.premacanada.ca](http://www.premacanada.ca)

## Wherever You Are Coast to Coast



### **ALBERTA 8**

- Northern 2
- Edmonton 2
- Central 2
- Calgary 1
- Southern Alberta 1

### **ONTARIO 17**

- North Western 1
- North Eastern 1
- South Western 3
- Central 8
- Eastern 4

### **QUEBEC 6**

- Northern 1
- Gatineau 1
- Montreal 1
- Southshore 1
- Quebec City 2

### **SASKATCHEWAN 4**

- Northern 2
- Southern 2

### **BRITISH COLUMBIA 11**

- Northern 3
- Vancouver Island 2
- Lower Mainland 2
- Interior 4

### **ATLANTIC CANADA 5**

- New Brunswick 1
- Nova Scotia and PEI 2
- Newfoundland 2

### **MANITOBA 4**

- West 1
- East 3



## TABLE OF CONTENTS

	<i>Page</i>
3610 — Air Hoses .....	36-2
3630 — Air Hose Connectors .....	36-4
3650 — Couplers and Adaptors .....	36-9



**PREMA**  
**Tire and Wheel  
Service Solutions**

### 3610-30 — 3/8" Hose



EASYFLEX HOSE



FLEXZILLA PRO HOSE

Code	Description	Size	NPT	PSI	Temperature Range
72-364	EasyFlex Technopolymer Air Hose With Brass Fitting	3/8" x 25'	1/4"	300	-54° to 65° C
72-368		3/8" x 50'	1/4"	300	-54° to 65° C
HFZ38250YW	Flexzilla Pro Polymer Heavy Duty Light Weight Air Hose	3/8" x 250'	1/4"	300	-40° to 140° F
HFZP3825YW2	HFZ38250YW — Bulk Roll on a Plastic Spool • Make Custom Hoses Without Crimping	3/8" x 25'	1/4"	300	-40° to 140° F
HFZP3850YW2		3/8" x 50'	1/4"	300	-40° to 140° F

### 3610-32 — 3/8" Reinforced Hose



REMA REINFORCED HOSE

Code	Description	Size	NPT	PSI	Temperature Range
890	Rema Reinforced Heavy Duty Non-Kink Air Hose	3/8" x 25'	1/4"	300	-40° to 200° F
891-THR		3/8" x 50'	1/4"	300	-40° to 200° F

### 3610-38 — 3/8" Hose Reels



79-334



79-335

Code	Description	Size	NPT	PSI
79-334	Maxreel Professional Air Hose Reel With Flexhybrid Hose • Reel Colour Grey	3/8" x 50'	1/4"	300
79-335	Maxreel Professional Air Hose Reel With Ecoflex Hose • Reel Colour Grey • Guard Bend Restrictor	3/8" x 50'	1/4"	300



### 3610-40 — 1/2" Hose

Code	Description	Size	NPT	PSI	Temperature Range
72-460	EasyFlex Hose Reel With Technopolymer Hose	1/2" x 500'		300	-54° to 65° C
72-465		1/2" x 25'	3/8"	300	-54° to 65° C
72-468	EasyFlex Technopolymer Hose With Brass Fitting	1/2" x 50'	1/2"	300	-54° to 65° C
72-469		1/2" x 50'	3/8"	300	-54° to 65° C
77-438	TopFlex Hose • NPT Male Ends	1/2" x 50'	1/2"	250	-29 to 99 °C
77-440		1/2" x 100'	1/2"	300	-29° to 99° C
77-445	TopFlex Rubber Lock-On Hose	1/2" x 25'	3/8"	300	-29° to 99° C
77-448		1/2" x 50'	3/8"	300	-29° to 99° C
HFZ12100YW3		1/2" x 100'	3/8"	300	-40° to 140° F
HFZ12250YW		1/2" x 250'		300	-40° to 140° F
HFZ1225YW3	Flexzilla Polymer Heavy Duty Light Weight Air Hose	1/2" x 25'	3/8"	300	-40° to 140° F
HFZ1250YW3		1/2" x 50'	3/8"	300	-40° to 140° F
HFZ1250YW4		1/2" x 50'	1/2"	300	-40° to 140° F



EASYFLEX HOSE (BULK)



EASYFLEX HOSE



TOPFLEX HOSE



FLEXZILLA HOSE

### 3610-42 — 1/2" Reinforced Hose

Code	Description	Size	NPT	PSI	Temperature Range
895	Rema Reinforced Heavy Duty Non-Kink Air Hose	1/2" x 50'	1/4"	300	-40° to 200° F
897		1/2" x 80'	1/4"	300	-40° to 200° F



REMA REINFORCED HOSE

### 3610-48 — 1/2" Hose Reels

MAXREEL Professional Hose Reels With Technopolymer and Rubber Hose • Fluid: Compressed Air • Automatic Rewind • Steel Construction • Corrosion-Resistant Epoxy Powder Coat Finish • Wide L-Shaped Base • Adjustable Guide Arm for Wall, Ceiling or Floor Mounting • 4-Direction Non-Snag Rollers to Reduce Hose Wear • Multi-Position Ratchet Lock and Easy Tension Adjustment • Fully Enclosed Spring • Inlet Hose Not Included

Size	Description	Size	NPT F	NPT M	PSI
79-336	Heavy Duty Spring Retractable Air Hose Reel With Hose	1/2" x 50'	INLET 1/2"	OUTLET 3/8"	300



### 3630-10 — 1/4" Fittings



Code	Description	Hose ID	Hose OD	NPT	PSI
22-123	1/4" Re-Usable Air Hose Repair Coupling		19/32"		
22-133			5/8"		
41-817	Brass Reusable Hose Fitting • Eliminate Need for Crimping • Not Recommended for Use With Thermoplastic Type Hoses	3/8"	5/8"	1/4" M	250
62-332	Free Angle Fitting • Chrome and Steel • Designed to Provide 360° Circular Rotation and Up To 90° of Angle for Air Tool and Air Hose Supply Lines • Full Flow Design			1/4" F 1/4" M	145
AH110	Brass Male Air Hose Barb Fitting	1/4"		1/4" M	
AH116		3/8"		1/4" M	
AH210		1/4"		1/4" F	
AH216		3/8"		1/4" F	
RP900250	Flexzilla 1/4" Reusable Fitting for Flexzilla and Flexzilla PRO Air Hoses • Anodized Aircraft Aluminum • 1/4" Barb			1/4" M	300 (Air) 150 (Water)

### 3630-12 — 1/4" Swivel Fittings



Code	Description	Hose ID	Hose OD	NPT	PSI
40-250	Push Connect Male Swivel Elbow Fitting		1/4"	1/8" M	
AH112	Brass Male Air Hose Swivel Barb Fitting	1/4"		1/4" M	
AH114	Brass Male Air Hose Ball Swivel Barb Fitting	1/4"		1/4" M	
IR-ASC-1/4	Swivel Fitting • Non-Marring Composite Swivel-It • 1/4" x 1/4"				
RP900250BS	Flexzilla 1/4" Reusable End With Ball Swivel • 1/4" Barb			1/4" M	300 (Air) 150 (Water)
RP900250S	Flexzilla 1/4" Reusable End With Swivel • 1/4" Barb			1/4" M	300 (Air) 150 (Water)

### 3630-14 — 1/4" Splicers



Code	Description	Hose ID	Hose OD	NPT	PSI
22-433	Re-Usable Air Hose Repair Coupling	1/4"	5/8"	1/4" M	250
AH410	Splicer/Repair Coupling • 1/4" Barb x 1/4" Barb				
RP901250	Flexzilla 1/4" Reusable Splicer • Anodized Aircraft Aluminum				



### 3630-16 — 1/4" Manifolds

Code	Description	NPT	PSI
AH440	3-In-1 Hose Manifold	1/4" F	300

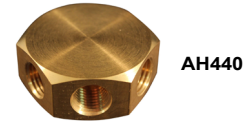

### 3630-24 — 5/16" Splicers

Code	Description
AH411	Brass Air Hose Splicer/Repair Coupling • Use With Ferrules or Hose Clamps to Splice Air Line Hose • 5/16" Barb x 5/16" Barb



### 3630-30 — 3/8" Fittings

Code	Description	Hose ID	Hose OD	NPT
22-163	Re-Usable Air Hose Repair Coupling		11/16"	3/8" M
22-172	Re-Usable Air Hose Repair Coupling		3/4"	3/8" M
AH120	Brass Male Air Hose Barb Fitting	1/4"		3/8" M
AH122	Brass Male Air Hose Barb Fitting	3/8"		3/8" M
AH124	Brass Male Air Hose Swivel Barb Fitting	3/8"		3/8" M
AH128	Brass Male Air Hose Barb Fitting	1/2"		3/8" M
AH222	Brass Female Air Hose Barb Fitting	3/8"		3/8" F
RP900375	Flexzilla 3/8" Reusable End • Anodized Aircraft Aluminum			1/4" M



### 3630-32 — 3/8" Swivel Fittings

Code	Description
RP900375BS	Flexzilla 3/8" Reusable End with Ball Swivel • Anodized Aircraft Aluminum
RP900375S	Flexzilla 3/8" Reusable End with Swivel • Anodized Aircraft Aluminum



### 3630-34 — 3/8" Splices

Code	Description
AH420	Brass Air Hose Splicer/Repair Coupling • 3/8" Barb x 3/8" Barb
RP901375	Flexzilla 3/8" Reusable Splicer • Anodized Aircraft Aluminum



### 3630-40 — 1/2" Fittings



41-604

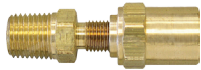

41-830



AH132

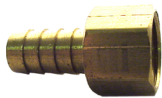

AH232



RP900500

Code	Description	Hose ID	Hose OD	NPT	PSI	Working Temperature
41-604	Brass Hose Fitting 3/4" Barb	3/4"		1/2" M	150	-40 - 71 °C
41-830	Brass Reusable Fitting for Rubber Hose • Eliminates Need for Crimping • Not recommended for Use With Thermoplastic Type Hoses	1/2"	7/8"	1/2" M	250	-40 - 107 °C
AH130	Brass Male Air Hose Barb Fitting	3/8"		1/2" M		
AH132	Brass Male Air Hose Barb Fitting	1/2"		1/2" M		
AH232	Brass Female Air Hose Swivel Barb Fitting • Permits Rotation of Fitting Without Kinking or Twisting of Hose	1/2"		1/2" F		
RP900500	Flexzilla 1/2" Reusable Fitting for Flexzilla and Flexzilla PRO Air Hoses • Anodized Aircraft Aluminum • 1/2" Barb			3/8" M	300 (Air) 150 (Water)	

### 3630-42 — 1/2" Swivel Fittings



RP900500S

Code	Description	NPT	PSI
RP900500S	Flexzilla 1/2" Reusable End With Swivel • 1/2" Barb	3/8" M	300 (Air) 150 (Water)

### 3630-44 — 1/2" Splices



AH430



RP901500

Code	Description
AH430	Splicer Fitting 1/2"
RP901500	Flexzilla 1/2" Reusable Splicer



### 3630-70 — Adaptors

Code	Description	NPT
653-4	Brass Air Hose Adaptor	3/8" M to 1/2" F
AH450	Brass Air Hose Adaptor	1/4" M to 3/8" F
AH451	Brass Air Hose Adaptor	3/8" M to 1/4" M
AH452	Brass Air Hose Adaptor	1/2" M to 1/4" F
AH453	Brass Air Hose Adaptor	1/2" M to 3/8" F



653-4



AH451

### 3630-72 — Bushings

Code	Description	NPT
120-DB	Reducer Bushing	1/2" F to 1/4" M
122-DB	Reducer Bushing	1/2" M to 1/4" M
21-515	Reusable Hose Coupler	1/4" F to 1/4" F
647-2	Bushing	1/2" M / 1/2" M
AH462	Bushing	1/4" M / 1/4" M
AH463	Bushing	3/8" M / 1/4" M



120-DB



122-DB



21-515



647-2



AH462

### 3630-74 — Clamps *cont'd on following page*

Code	Description
48-314	Zinc Plated Steel 2-Ear Pinch Clamp 11 - 13 mm • Commonly Used in Air, Fluid and Gas Line Applications • Minimum Order Quantity 10 Pieces
48-320	Zinc Plated Steel 2-Ear Pinch Clamp 15 - 18 mm • Commonly Used in Air, Fluid and Gas Line Applications • Minimum Order Quantity 10 Pieces
48-330	Zinc Plated Steel 2-Ear Pinch Clamp 23 - 27 mm • Commonly Used in Air, Fluid and Gas Line Applications • Minimum Order Quantity 10 Pieces
48-900	2-Ear Pinch Clamp Kit • 81 Piece Kit Includes: 48-600 Crimping Pincher Tool Along With the Following 2-Ear Type Clamps; (10) 7 - 9 mm, (10) 9 - 11 mm, (10) 11 - 13 mm, (10) 13 - 15 mm, (10) 15 - 18 mm, (10) 17 - 20 mm, (10) 20 - 23 mm, and (10) 23 - 27 mm
HC718	18 mm Crimp Type Hose Clamp • 25 per Box
HC720	20 mm Crimp Type Hose Clamp • 25 per Box
HC722	22 mm Crimp Type Hose Clamp • 25 per Box
HC8401-10	1" Open Pinch Clamp .882 • 10 Pack
HC8401-100	1" Open Pinch Clamp .882 • 100 Pack
HC8418-10	1-1/8" Open Pinch Clamp 1.00 • 10 Pack
HC8418-100	1-1/8" Open Pinch Clamp 1.00 • 100 Pack
HC8478-10	7/8" Open Pinch Clamp .764 • 10 pack
HC8478-100	7/8" Open Pinch Clamp .764 • 100 pack
HC8605-10	7/16" Open Pinch Clamp .378 • 10 pack
HC8605-100	7/16" Open Pinch Clamp .378 • 100 pack
HC8612-10	1/2" Open Pinch Clamp .425 • 10 Pack
HC8612-100	1/2" Open Pinch Clamp .425 • 100 Pack



PINCH CLAMP



48-900



CRIMP TYPE HOSE CLAMP



OPEN PINCH CLAMP

### 3630-74 — Clamps *cont'd from previous page*



Code	Description
HC8632-10	23/32" Open Pinch Clamp .602 • 10 pack
HC8632-100	23/32" Open Pinch Clamp .602 • 100 pack
HC8658-10	5/8" Open Pinch Clamp .52 • 10 pack
HC8658-100	5/8" Open Pinch Clamp .52 • 100 pack
HC8696-10	9/16" Open Pinch Clamp .472 • 10 pack
HC8696-100	9/16" Open Pinch Clamp .472 • 100 pack
OPK8498	91 Piece Pinch Clamp and Crimper Kit for Hose Repair • Includes: (1) Handheld Pinch Clamp Crimper, (10) 7/16", (15) 1/2", (10) 5/8", (10) 9/16", (20) 22/32", (10) 7/8", (10) 1", and (5) 1-1/8" Pinch Clamps

### 3630-76 — Ferrules



AH473

Code	Description
AH470	ID Hose Ferrule .527
AH471	ID Hose Ferrule .562
AH472	ID Hose Ferrule .593
AH473	ID Hose Ferrule .625
AH474	ID Hose Ferrule .656
AH475	ID Hose Ferrule .687
AH476	ID Hose Ferrule .718
AH477	ID Hose Ferrule .750
AH478	ID Hose Ferrule .781
AH479	ID Hose Ferrule .812

### 3630-80 — Crimp Tools



Code	Description
AH490	Hose Crimper Tool • Heavy Duty Ductile Iron Castings and Hardened Steel Dies Provide Long Service Life and Positive Crimping • Includes 5 Dies for Crimping 1/4" Braid to 3/8" Double Braided Hose

### 3630-90 — Filters

*Deluxe Inline Filter Protects Tools Against Corrosion, Condensation and Lack of Lubrication • Ideal for Job Applications When You Do Not Have Access to a Full FRL System*



Code	Description	NPT	PSI	Air Flow
S-637	1/4" Inline 40 Micron Filter • Aluminum	1/4" M 1/4" F	150	Up to 20 CFM



### 3650 — Couplers and Adaptors Chart

Quick Connect Couplings are a Fast and Easy Means of Joining Various Pneumatic Transfer Lines • An Automatic Shut-Off Valve in the Coupler End Allows the Quick Connects to be Disengaged Without Needing a Separate Ball or Line Valve • The Size of the Inlet Thread is a Good Indication of the Proper Coupler Size to Use in Order to Maximize Feasibility and Flow • A Short (3-10 Ft) Lead-In or Whip Hose Coupled With Solid Male NPT Ends Will Prolong Coupler Life as it Will Absorb Vibration and Reduce Metal Fatigue • You Can Differentiate Between Various Interchange Series by Observing the Differences in the Adaptor / Plug Nose As Well As With Differences in the Coupler Sleeve • These Quick Connects Will Interchange With Many Popular Brand Names, Such As: Amflo, Aro, Camel, Cejn, Coilhose, Dill, Dixon, Foster, Hansen, Lincoln, Milton, Nycoil, Parker, Perfecting, Schrader, Tomco, and Tru-Flate

#### QUICK CONNECT ADAPTOR PROFILES CHART

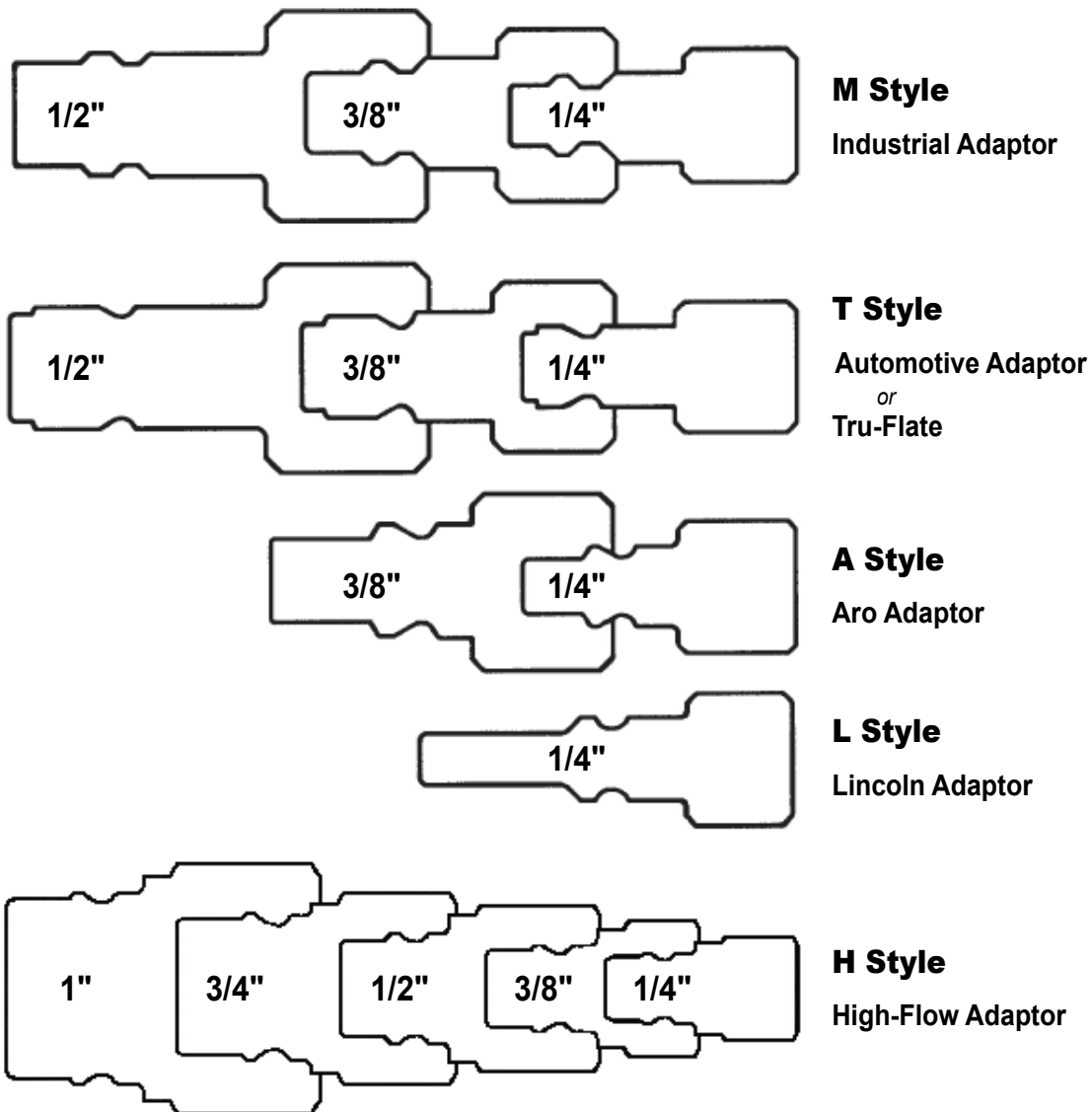

## 3650-10 — 1/4" Couplers



MIL-715



MIL-718



MIL-775

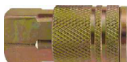

VHC15

### M STYLE — INDUSTRIAL INTERCHANGE

Code	Style	Description	Thread Size	Thread Type
MIL-715	M	Industrial 1/4" Coupler	1/4"	FNPT
MIL-718	M	M-Style 1/4" Coupler	3/8"	FNPT
MIL-755	M	Industrial 1/4" Push Type Coupler	1/4"	FNPT
VHC15	M	Industrial 1/4" Coupler	1/4"	FNPT



8888



MIL-755



VHC75

### A STYLE — ARO INTERCHANGE

Code	Style	Description	Thread Size	Thread Type
8888	A	ARO 1/4" Coupler	1/4"	FNPT
MIL-775	A	ARO 1/4" Coupler	1/4"	FNPT
VHC75	A	ARO 1/4" Coupler	1/4"	FNPT



790



D123



VHC90

### L STYLE — LINCOLN INTERCHANGE

Code	Style	Description	Thread Size	Thread Type
790	L	Lincoln 1/4" Coupler	1/4"	FNPT
D123	L	Lincoln 1/4" Coupler	1/4"	FNPT
VHC90	L	Lincoln 1/4" Coupler	1/4"	FNPT



D-13R



MIL-787

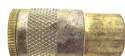

VHC85

### T STYLE — TRU-FLATE INTERCHANGE

Code	Style	Description	Thread Size	Thread Type
D-13R	T	Tru-Flate 1/4" Coupler	1/4"	FNPT
MIL-787	T	Tru-Flate 1/4" Coupler	1/4"	FNPT
VHC85	T	Tru-Flate 1/4" Coupler	1/4"	FNPT



MIL-764

### H STYLE — HIGH FLOW INTERCHANGE

Code	Style	Description	Thread Size	Thread Type
MIL-764	H	Hi-Flo 1/4" V-Style Coupler	1/4"	FNPT



VHC50

### M/T/A STYLE — MISC INTERCHANGE

Code	Style	Description	Thread Size	Thread Type
VHC50	M/T/A	Triple Interchange 1/4" Coupler	1/4"	FNPT

### 3650-15 — 1/4" Adaptors

#### M STYLE — INDUSTRIAL INTERCHANGE

Code	Style	Description	Thread Size	Thread Type
VHC27	M	Industrial 1/4" Adaptor	1/4"	MNPT
VHC28	M	Industrial 1/4" Adaptor	1/4"	FNPT
MIL-731	M	Industrial 1/4" Adaptor • Standard Bore Outer Valve Stem Thread	.305-32	F



VHC27



VHC28



MIL-731

#### A STYLE — ARO INTERCHANGE

Code	Style	Description	Thread Size	Thread Type
VHC77	A	ARO 1/4" Adaptor	1/4"	MNPT
VHC78	A	ARO 1/4" Adaptor	1/4"	FNPT



VHC77



VHC78

#### L STYLE — LINCOLN INTERCHANGE

Code	Style	Description	Thread Size	Thread Type
26-142	L	Lincoln 1/4" Adaptor	1/4"	FNPT
26-242	L	Lincoln 1/4" Adaptor	1/4"	MNPT
VHC91	L	Lincoln 1/4" Adaptor	1/4"	MNPT
VHC92	L	Lincoln 1/4" Adaptor	1/4"	FNPT



26-142



26-242



VHC91



VHC92

#### T STYLE — TRU-FLATE INTERCHANGE

Code	Style	Description	Thread Size	Thread Type
VHC83	T	Tru-Flate 1/4" Adaptor	1/4"	MNPT
VHC84	T	Tru-Flate 1/4" Adaptor	1/4"	FNPT
VHC84B	T	Tru-Flate 1/4" Adaptor • Brass	1/4"	FNPT
D-6C	T	Tru-Flate Adaptor • Standard Bore Outer Valve Stem Thread	.305-32	F
D-7C	T	Tru-Flate Adaptor • Short	.485-26	F
D-7CR	T	Tru-Flate Adaptor • 2-1/4" for Retread Envelopes	.485-26	F
D-7CRL	T	Tru-Flate Adaptor • 3-3/4" for Retread Envelopes	.485-26	F



VHC83



VHC84



VHC84B



D-6C



D-7C



D-7CR



D-7CRL

#### H STYLE — HIGH FLOW INTERCHANGE

Code	Style	Description	Thread Size	Thread Type
MIL-760-1	H	Hi-Flo 1/4" V-Style Adaptor	1/4"	MNPT
MIL-761-1	H	Hi-Flo 1/4" V-Style Adaptor	1/4"	FNPT



MIL-760-1



MIL-761-1



### 3650-30 — 3/8" Couplers



117



MIL-1813



MIL-1833



MIL-1835

#### M STYLE — INDUSTRIAL INTERCHANGE

Code	Style	Description	Thread Size	Thread Type
117	M	Industrial Coupler 3/8"	3/8"	FNPT
MIL-1813	M	Industrial Coupler 3/8"	3/8"	FNPT
MIL-1833	H	Industrial Coupler 3/8"	1/4"	FNPT
MIL-1835	H	Industrial Coupler 3/8"	3/8"	FNPT

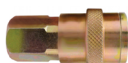

25-864



D-15R



MIL-1805



VHC803



VHC805

#### T STYLE — TRU-FLATE INTERCHANGE

Code	Style	Description	Thread Size	Thread Type
25-864	T	Tru-Flate 3/8" Maxquick Coupler	3/8"	FNPT
D-15R	T	Tru-Flate 3/8" Coupler	1/4"	FNPT
D-15R-38	T	Tru-Flate 3/8" Coupler	3/8"	FNPT
MIL-1805	T	Tru-Flate Heavy Duty 3/8" Coupler	3/8"	FNPT
VHC803	T	Tru-Flate Heavy Duty 3/8" Coupler	1/4"	FNPT
VHC805	T	Tru-Flate Heavy Duty 3/8" Coupler	3/8"	FNPT

### 3650-35 — 3/8" Adaptors



122



MIL-1837



MIL-1838



MIL-1839



MIL-1840

#### M STYLE — INDUSTRIAL INTERCHANGE

Code	Style	Description	Thread Size	Thread Type
122	M	Industrial 3/8" Adaptor	3/8"	MNPT
MIL-1837	M	Industrial 3/8" Adaptor	3/8"	MNPT
MIL-1838	M	Industrial 3/8" Adaptor	3/8"	FNPT
MIL-1839	M	Industrial 3/8" Adaptor	1/4"	MNPT
MIL-1840	M	Industrial 3/8" Adaptor	1/4"	FNPT



MIL-1807



MIL-1809



VHC807



VHC808



VHC809



VHC810

#### T STYLE — TRU-FLATE INTERCHANGE

Code	Style	Description	Thread Size	Thread Type
MIL-1807	T	Tru-Flate 3/8" Adaptor	3/8"	MNPT
MIL-1809	T	Tru-Flate 3/8" Adaptor	1/4"	MNPT
VHC807	T	Tru-Flate 3/8" Adaptor	3/8"	MNPT
VHC808	T	Tru-Flate 3/8" Adaptor	3/8"	FNPT
VHC809	T	Tru-Flate 3/8" Adaptor	1/4"	MNPT
VHC810	T	Tru-Flate 3/8" Adaptor	1/4"	FNPT

### 3650-40 — 1/2" Couplers

#### T STYLE — TRU-FLATE INTERCHANGE

Code	Style	Description	Thread Size	Thread Type
CO-111R	T	Tru-Flate Heavy Duty 1/2" Coupler	1/2"	FNPT
D-17R	T	Tru-Flate Heavy Duty 1/2" Coupler	1/2"	FNPT
MIL-1815	M	Industrial Coupler 1/2"	1/2"	FNPT
VHC815	T	Tru-Flate Heavy Duty 1/2" Coupler	1/2"	FNPT



CO-111R



D-17R



MIL-1815



VHC815

### 3650-45 — 1/2" Adaptors

#### M STYLE — INDUSTRIAL INTERCHANGE

Code	Style	Description	Thread Size	Thread Type
22-242	M	Industrial 1/2" Adaptor	1/4"	MNPT
MIL-1857	M	Industrial 1/2" Adaptor	1/2"	MNPT
MIL-1858	M	Industrial 1/2" Adaptor	1/2"	FNPT
MIL-1859	M	Industrial 1/2" Adaptor	3/8"	MNPT
MIL-1860	M	Industrial 1/2" Adaptor	3/8"	FNPT



22-242



MIL-1857



MIL-1858



MIL-1859



MIL-1860

#### T STYLE — TRU-FLATE INTERCHANGE

Code	Style	Description	Thread Size	Thread Type
MIL-1817	T	Tru-Flate 1/2" Adaptor	1/2"	MNPT
MIL-1818	T	Tru-Flate 1/2" Adaptor	1/2"	FNPT
MIL-1819	T	Tru-Flate 1/2" Adaptor	3/8"	MNPT
MIL-1820	T	Tru-Flate 1/2" Adaptor	3/8"	FNPT
VHC817	T	Tru-Flate 1/2" Adaptor	1/2"	MNPT
VHC818	T	Tru-Flate 1/2" Adaptor	1/2"	FNPT



MIL-1817



MIL-1818



MIL-1819



MIL-1820



VHC817



VHC818

Part # — Page	Part # — Page	Part # — Page	Part # — Page
21-515 — 36-7	AH124 — 36-5	HC8605-100 — 36-7	RP900375 — 36-5
22-123 — 36-4	AH128 — 36-5	HC8612-10 — 36-7	RP900375BS — 36-5
22-133 — 36-4	AH130 — 36-6	HC8612-100 — 36-7	RP900375S — 36-5
22-163 — 36-5	AH132 — 36-6	HC8632-10 — 36-8	RP900500 — 36-6
22-172 — 36-5	AH210 — 36-4	HC8632-100 — 36-8	RP900500S — 36-6
22-242 — 36-13	AH216 — 36-4	HC8658-10 — 36-8	RP901250 — 36-4
22-433 — 36-4	AH222 — 36-5	HC8658-100 — 36-8	RP901375 — 36-5
25-864 — 36-12	AH232 — 36-6	HC8696-10 — 36-8	RP901500 — 36-6
26-142 — 36-11	AH410 — 36-4	HC8696-100 — 36-8	S-637 — 36-8
26-242 — 36-11	AH411 — 36-5	HFZ1225YW3 — 36-3	VHC15 — 36-10
40-250 — 36-4	AH420 — 36-5	HFZ1250YW3 — 36-3	VHC27 — 36-11
41-604 — 36-6	AH430 — 36-6	HFZ1250YW4 — 36-3	VHC28 — 36-11
41-817 — 36-4	AH440 — 36-5	HFZ12100YW3 — 36-3	VHC50 — 36-10
41-830 — 36-6	AH450 — 36-7	HFZ12250YW — 36-3	VHC75 — 36-10
48-314 — 36-7	AH451 — 36-7	HFZ38250YW — 36-2	VHC77 — 36-11
48-320 — 36-7	AH452 — 36-7	HFZP3825YW2 — 36-2	VHC78 — 36-11
48-330 — 36-7	AH453 — 36-7	HFZP3850YW2 — 36-2	VHC83 — 36-11
48-900 — 36-7	AH462 — 36-7	IR-ASC-1/4 — 36-4	VHC84 — 36-11
62-332 — 36-4	AH463 — 36-7	MIL-715 — 36-10	VHC84B — 36-11
72-364 — 36-2	AH470 — 36-8	MIL-718 — 36-10	VHC85 — 36-10
72-368 — 36-2	AH471 — 36-8	MIL-731 — 36-11	VHC90 — 36-10
72-460 — 36-3	AH472 — 36-8	MIL-755 — 36-10	VHC91 — 36-11
72-465 — 36-3	AH473 — 36-8	MIL-760-1 — 36-11	VHC92 — 36-11
72-468 — 36-3	AH474 — 36-8	MIL-761-1 — 36-11	VHC803 — 36-12
72-469 — 36-3	AH475 — 36-8	MIL-764 — 36-10	VHC805 — 36-12
77-438 — 36-3	AH476 — 36-8	MIL-775 — 36-10	VHC807 — 36-12
77-440 — 36-3	AH477 — 36-8	MIL-787 — 36-10	VHC808 — 36-12
77-445 — 36-3	AH478 — 36-8	MIL-1805 — 36-12	VHC809 — 36-12
77-448 — 36-3	AH479 — 36-8	MIL-1807 — 36-12	VHC810 — 36-12
79-334 — 36-2	AH490 — 36-8	MIL-1809 — 36-12	VHC815 — 36-13
79-335 — 36-2	CO-111R — 36-13	MIL-1813 — 36-12	VHC817 — 36-13
79-336 — 36-3	D-6C — 36-11	MIL-1815 — 36-13	VHC818 — 36-13
117 — 36-12	D-7C — 36-11	MIL-1817 — 36-13	
120-DB — 36-7	D-7CR — 36-11	MIL-1818 — 36-13	
122 — 36-12	D-7CRL — 36-11	MIL-1819 — 36-13	
122-DB — 36-7	D-13R — 36-10	MIL-1820 — 36-13	
647-2 — 36-7	D-15R — 36-12	MIL-1833 — 36-12	
653-4 — 36-7	D-15R-38 — 36-12	MIL-1835 — 36-12	
790 — 36-10	D-17R — 36-13	MIL-1837 — 36-12	
890 — 36-2	D123 — 36-10	MIL-1838 — 36-12	
891-THR — 36-2	HC718 — 36-7	MIL-1839 — 36-12	
895 — 36-3	HC720 — 36-7	MIL-1840 — 36-12	
897 — 36-3	HC722 — 36-7	MIL-1857 — 36-13	
8888 — 36-10	HC8401-10 — 36-7	MIL-1858 — 36-13	
AH110 — 36-4	HC8401-100 — 36-7	MIL-1859 — 36-13	
AH112 — 36-4	HC8418-10 — 36-7	MIL-1860 — 36-13	
AH114 — 36-4	HC8418-100 — 36-7	OPK8498 — 36-8	
AH116 — 36-4	HC8478-10 — 36-7	RP900250 — 36-4	
AH120 — 36-5	HC8478-100 — 36-7	RP900250BS — 36-4	
AH122 — 36-5	HC8605-10 — 36-7	RP900250S — 36-4	

## A

### Air Hose Connectors

- Adaptors: 36-7
- Bushings: 36-7
- Clamps: 36-7, 36-8
- Crimp Tools: 36-8
- Ferrules: 36-8
- Filters: 36-8
- Fittings: 36-4, 36-5, 36-6
- Manifolds: 36-5
- Splices: 36-4, 36-5, 36-6

### Air Hoses

- Hose Reels: 36-2, 36-3
- Hoses: 36-2, 36-3

## C

### Couplers and Adaptors

- Adaptors: 36-11, 36-12, 36-13
- Couplers: 36-10, 36-12, 36-13
- Quick Connect Adaptor Profiles Chart: 36-9











# DID YOU KNOW PREMA CARRIES A FULL LINE OF TIRE REPAIR EQUIPMENT AND SUPPLIES AND IS IN YOUR AREA?

An extensive line of brand name products, all competitively priced.

## **Tire Repair Materials & Chemicals**

Radial Repairs  
Bias Repairs  
Agriculture Repairs  
OTR Repairs  
Tube Stems  
Universal Repairs  
Combi Patch/Plugs  
Pre-Buff Cleaners  
Vulcanizing Cements  
Over-Buff Sealers  
Bead Sealers

## **Lifting Tools**

Bottle Jacks  
Hydraulic Rams  
Lift Pads  
Floor Jacks  
Jack Stands  
Forklift Jacks  
Garage Jacks  
Bladder Jacks

## **Service Chemicals**

Mounting Compound  
Murphy's Liquid Lubricants  
Brake Cleaner  
Penetrants  
Universal Paste  
SKID  
Silicone Sprays  
Tire Sealant  
Tire Paint  
Tire Shine  
Winter Lubricants

## **Shop Supplies & Equipment**

Hand Cleaner  
Tire Bags  
Dunk Tanks  
Work Gloves  
Nitrile Gloves  
Seat Gloves  
Seat Covers  
Tire Carts  
Floor Mats

## **Tire Repair Tools**

Brushes  
Adaptors  
Reamers  
Probe Tools  
Scrapers  
Carbide Cutters  
Insert Tools  
Buffing Stones  
Tire Spreaders

## **Wheel Weights & Balancing Beads**

Passenger Weights  
Truck Weights  
3M Balancing System  
Coloured Weights  
Zinc Weights  
Steel Weights  
Magnum Balancing Beads  
Counteract Balancing Beads

## **Wheel Balancing Tools**

Adhesive Wheel Weight Remover  
Wheel Weight Hammers  
Haweka Flange Plates  
Duo Collets  
Haweka Quick Plates  
Haweka Quick Nuts  
Replacement Shafts  
Cones

## **Air Tools & Accessories**

IR Impact Wrenches  
IR Replacement Parts  
CP Impact Wrenches  
CP Replacement Parts  
Tool Covers  
Sockets  
Ratchets  
3M Abrasives  
Grinders  
Buffers  
Needle Scalers

## **Valves**

Passenger  
Truck  
OTR  
Air Liquid  
Super Large Bore  
Straight or Bent Caps & Cores  
Brass or Nickel Alcoa Valves  
Enki Valves  
4-Way Tools  
Fishing Tools  
Double Seal Caps  
Installation Tools  
Grommets  
O-Rings

## **Wheel Service Tools & Equipment**

Bead Breakers  
Torque Wrenches  
Bead Blasters and Bazookas  
Hydraulic Pumps  
Fasteners (Nuts, Studs & Clamps)  
Tire Irons & Bead Hammers  
Calcium Pumps  
Wheel Guards  
Mount/Demount Tools  
Hydraulic Rams

## **Gauges & Air Controls**

Pencil Gauges  
Master Gauges  
Truck Gauges  
Inflation Gauges  
Calibratable Gauges  
Digital Gauges  
Al Liquid  
Chucks  
Nipples  
Couplers  
Bushings  
Crimpers  
Hoses  
Ferrules  
Manifolds  
Whip Hoses

## **TPMS**

EZ-Sensor  
Redi-Sensor  
OE Replacement  
Sensors  
Replacement Valves  
Scan Tools (w/OBD)  
Service Kits  
Torque Wrenches  
T-10 & T-20 Screw  
Drivers  
Core Tools

## **Retread**

Envelopes  
Rasps  
Grinding Stones  
Carbide Cutters  
Hub Lube  
Mold Release  
Rope Rubber  
Sprayers  
Blades  
Cement  
Cushion Rubber  
Poly Film  
Wicking Pads  
Staples

## **Section Repair**

Vulcanizers  
Cushion Rubber  
Cup Cutters  
Carbide Cutters  
Tire Stands  
HD Skivers  
Hand Tools  
Flex Shaft Buffers  
Rope Rubber  
Rasps  
Grinding Stones

## **Miscellaneous**

Tire Studs  
Stud Guns  
Jaw Covers  
Duckheads  
Plastic Inserts  
Brake Lathe Bits  
O-Rings  
Arctic O-Rings

## **Your Authorized Distributor**

### **Prema Canada**

3230 Mainway - Unit 3, Burlington, ON L7M 1A5  
Toll Free: 1.800.268.6311  
Phone: 905.628.2303  
Fax: 905.628.3646  
Inquires: [sales@premacanada.ca](mailto:sales@premacanada.ca)  
[www.premacanada.ca](http://www.premacanada.ca)

Distributor contact information also available at [www.premacanada.ca](http://www.premacanada.ca)